

Paveosub-118

Bass reflex subwoofer



Herzlichen Dank,
dass Sie ein Voice-Acoustic Produkt gekauft haben.
Seit dem Jahr 2006 entwickeln wir unsere Produkte
in der Überzeugung, dass es auf die Details ankommt.
Wir wünschen Ihnen viel Freude mit diesem Produkt.

Thank you very much,
for purchasing a Voice-Acoustic product.
Since 2006 we have been developing our
products in the firm belief that details matter.
May we wish you a lot of pleasure with this product.

Muchas gracias
por haber comprado un producto de Voice-Acoustic.
Desde el año 2006 estamos desarrollando nuestros productos
estando convencidos, que son los detalles que cuentan.
Le(s) deseamos mucha alegría usando este producto.

Merci beaucoup
d´avoir acheté un produit Voice-Acoustic.
Depuis 2006, nous développons des produits
avec la ferme conviction que les détails comptent.
Nous vous souhaitons beaucoup de plaisir à utiliser ce produit.



Introduction

General Safety Instructions	4
Care	4
Transport and storage	4
Warranty	4
Components	5
Technical data	6
Connections	6
Setup	7
Connecting cables	7
Operation	7

Working with Paveosub-118

Mounting and dismounting the wheelboard	8
Use of the side lashing rings	8
Overview Accessories	9

Manufacturer's declaration

Imprint	10
---------------	----

General Safety Instructions:

Loudspeakers produce a static magnetic field even if they are not connected or are not in use. Therefore make sure when erecting and transporting loudspeakers that they are nowhere near equipment and objects which may be impaired or damaged by an external magnetic field. Persons with cardiac pacemakers must maintain a safe distance.

The minimum recommended safety clearance is 1 m.

Never stand in the immediate vicinity of loudspeakers driven at a high level. Professional loudspeaker systems are capable of causing a sound pressure level detrimental to human health. Seemingly non-critical sound levels (from approx. 90 dB SPL) can cause hearing damage if people are exposed to it over a long period.

All connected cables must be laid in such a way that they cannot be crushed by objects and that nobody can step on them! Replace damaged cables immediately and do not use them!

Use only accessory parts specified by Voice-Acoustic or original accessory parts from Voice-Acoustic. Check all cabinets and accessories regularly for wear and replace them if necessary.

Do not set up the loudspeakers in places where they are permanently exposed to moisture, dust, dirt or direct sunlight.

Care

Wipe the surface of loudspeakers only with a damp cloth and pure water. In case of heavy pollution, repeat the above procedure several times if necessary. Do not use any chemical additives or aggressive detergents, as these may harm and damage the surfaces.

Transport and storage

When transporting and storing the unit, it is important to ensure that the surface and front grill of the loudspeaker are not damaged. Moisture can penetrate through exposed wood surfaces and cause the wood to swell. A bent or broken front grill will no longer adequately protect the sensitive speaker membranes. In addition, appreciable dust deposits may considerably impair the functionality of a loudspeaker membrane. For this reason, the loudspeakers should be transported and stored in a safe, careful, dry and largely dust-free manner.

The following accessory parts for transport and storage are available from Voice-Acoustic:

- Transport and rain cover for Paveosub-118 (Art.-Nr. 501181000)
- Detachable wheelboard for Paveosub-118 (Art.-Nr. 501184000)

Note: *The original packaging is unsuitable as permanent storage and transport packaging!*

Warranty

The warranty period is 24 months from date of delivery.

On our choice we will eliminate any lack of conformity with repair or with replacement of the faulty goods. The place of performance for warranty services is Voice-Acoustic headquarters in Dörverden. In case of remedy of defects, the buyer shall bear all costs resulting from transportation of the goods to Voice-Acoustic headquarters in Dörverden.

The ordering party is not entitled to remedy the defect by itself or to organise a replacement and to charge such activities to Voice-Acoustic. In case of self remedy by the ordering party the warranty given by Voice-Acoustic becomes void.

Warranty doesn't apply to parts of wear and tear, such as threaded points, M20 flanges, lashing rings, rubber feet and the SpeakON® connectors.

Components

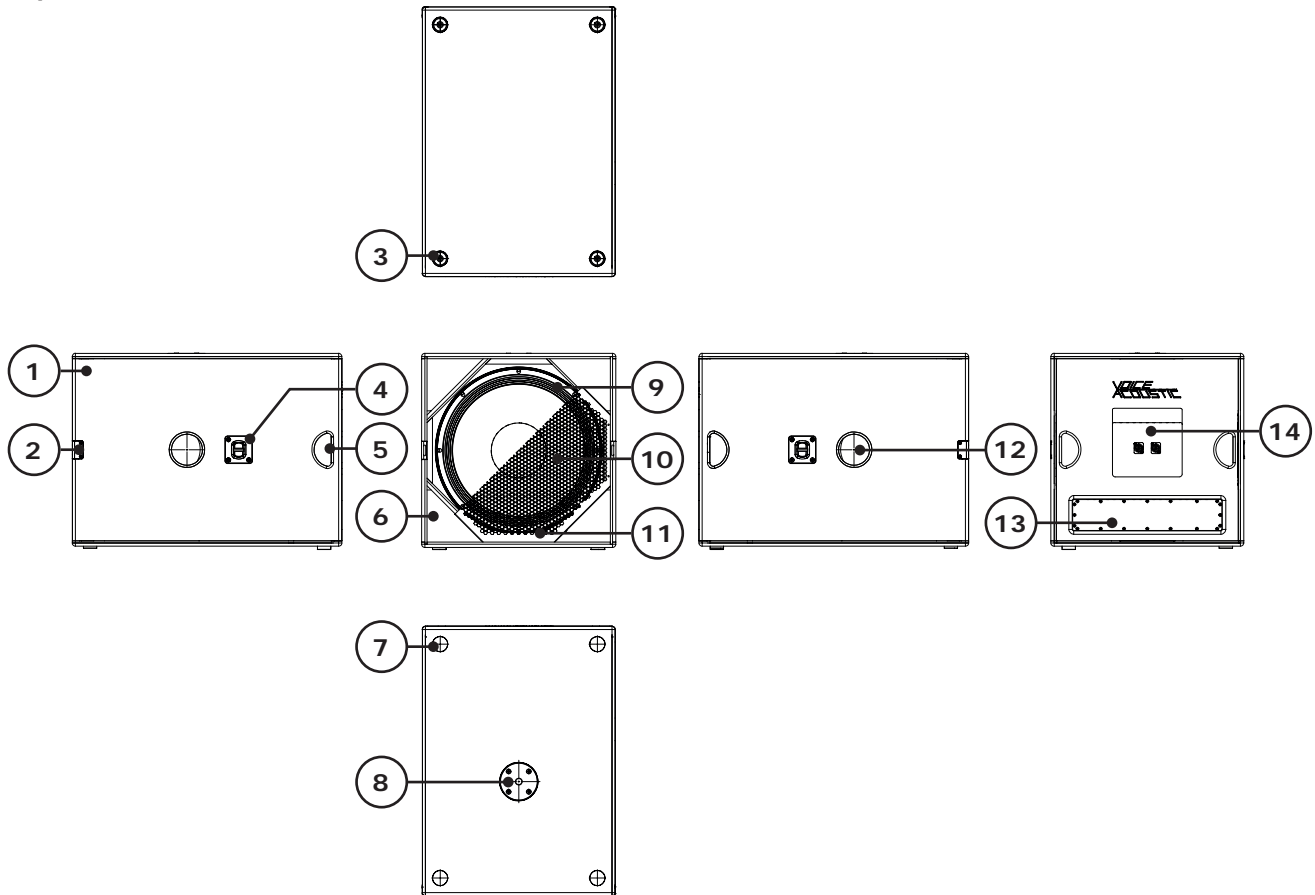

1. 24 und 15 mm multiplex cabinet, Warnex textured paint finish
2. Butterfly holders on both sides for front wheelboard
3. 4 x rubber feet on the underside
4. Lashing rings on both sides, e.g. for lashing in stacks, or load securing
5. Handles on both sides in the back
6. 4 x bass reflex ports in the corners
7. 4 x stacking troughs in the upper side
8. M20 Mounting flange for spacer rod
9. 18" Neodym long excursion woofer
10. Front grille 1 mm with 10 mm acoustic foam
11. Two additional SpeakON® sockets for front cabling (not on Paveosub-118sp)
12. Handles on both sides in the side walls
13. Cover plate (The subwoofer can be upgraded to the self-powered version at the factory)
14. Connector panel with two SpeakON® connectors and Type plate with serial number

Technical data

Components	1 x 18" Neodym long excursion woofer (LF) with 4" voice coil
Lower cut-off frequency	33 Hz (- 10 dB) 39 Hz (- 3 dB)
Coverage range (h x v)	Omnidirektional
Powerhandling	1.200 W AES / 2.400 W program / 4.800 W peak at 8 Ω
Sound pressure	131 dB SPL AES / 134 dB SPL program / 137 dB SPL peak
Dimensions / Weight	540 (h) x 540 (w) x 740 (d) mm / 41 kg
Finish	Warnex texture paint

Connections

The loudspeaker has four loop-through Neutrik NL4 SpeakON® IN/OUT connectors. They use the 2+/2- connection pins. Additional loudspeakers can be looped through via the second connector. In addition to the rear connector panel, two front SpeakON® connectors are available in the front grille.

The configuration of the front SpeakON® connectors can be changed from standard 2+/2- to 1+/1- on a board behind the front grille, so that cardioid bass arrays can easily be looped through with a 4-pole cable.

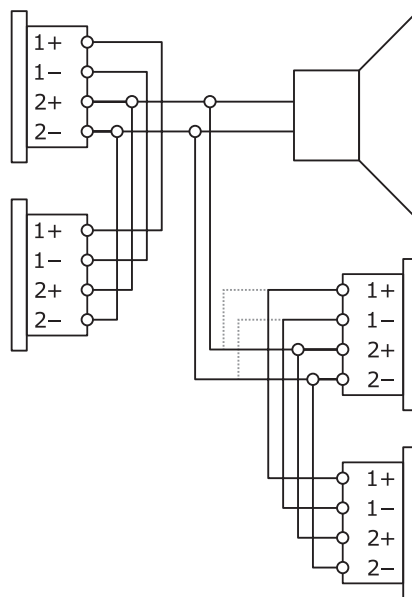

Setup

The Paveosub-118 is designed for stationary operation. Ensure that the subwoofer is in a secure position to prevent personal injury and property damage.

Connecting cables

When connecting the cables to the loudspeaker, ensure that the polarity (+/-) and pin assignment (1/2) is correct. Incorrect connection results in a significant change in the loudspeaker sound characteristics and may damage the compression driver.

The two connection sockets on the back of the loudspeaker can be used to link multiple loudspeakers on a single amplifier. Note that parallel connection reduces the total impedance (Ω) seen by the amplifier. The total impedance of loudspeakers connected in parallel must not drop below the minimum operating impedance of the amplifier.

Voice-Acoustic recommends to use the available 4 x 4 mm² Speakon cables for mobile use.

We recommend wiring the basses with at least 4 mm² in installations. The cables of the tops in installations must be sufficiently dimensioned according to impedance, power and cable length.

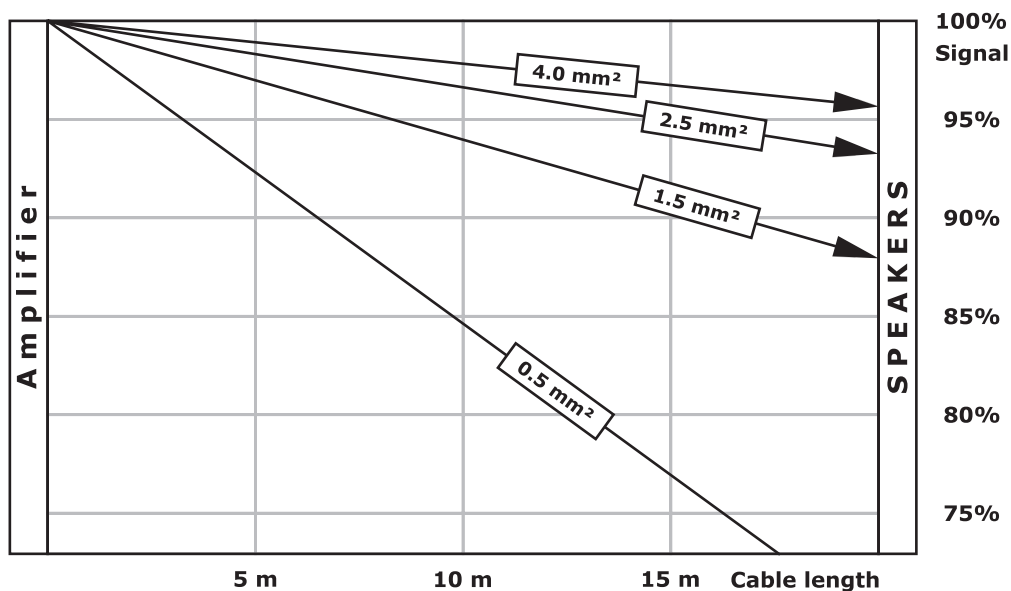

Simplified display without consideration of loudspeaker impedances

Operation

The Paveosub-118 is designed exclusively for use with Voice-Acoustic system electronics with internal DSP controller: The HDSP amplifiers or powered by the free 2.400 W amplifier channels of the self-powered subwoofers.

Make sure the appropriate preset has been selected before connecting the speaker to the system power amp or self-powered subwoofer.

Using the wrong preset can damage parts of the loudspeaker.

Note: *If the Paveosub-118 is not operated on the intended Voice-Acoustic system electronics, the manufacturer's warranty for the loudspeaker expires!*

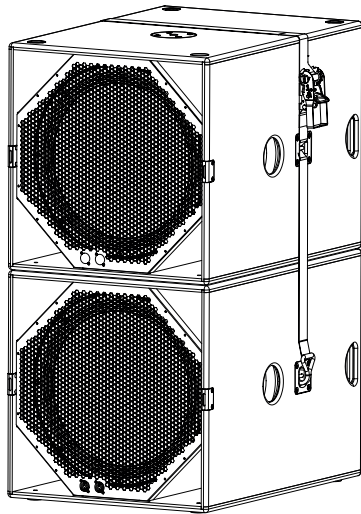
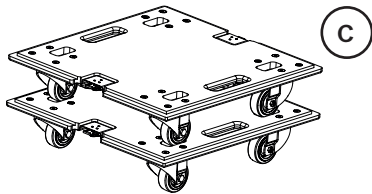
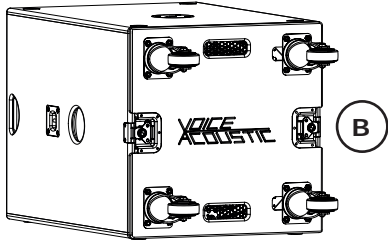
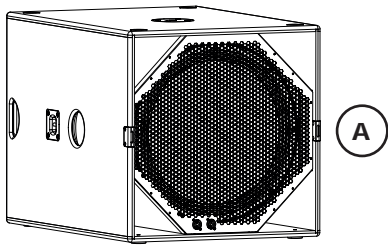

Mounting and dismounting the wheelboard

For easy transport of the subwoofer and protection of the front grille, use the detachable wheelboard.

1. Place the wheelboard with the butterfly locks (A) on the butterfly holders (B) on the frontside.
2. Turn the two butterfly locks right until they are clicked into place.
3. Now the subwoofer can be placed on the wheels for transport.

Note: The wheelboard must not be mounted during operation, as the bass reflex port is closed and the chassis may be damaged!

1. To remove the wheelboard, tilt the subwoofer onto the four rubber feet.
2. Turn the two butterfly locks left until the wheelboard can be removed.

Note: The wheelboard has stacking troughs (C), so that several wheelboards can be stacked on top of each other!

Use of the side lashing rings

Stacked systems must always be additionally secured against falling over, otherwise the stability is not guaranteed.

The Paveosub-118 has lashing rings on the sides.

Only use straps with a max. width of 25 mm.

To prevent the strap from slipping, always pull the strap through all lashing rings.

Overview Accessories



Transport and rain cover for Paveosub-118 (Art.-Nr. 501181000)



Detachable wheelboard for Paveosub-118 (Art.-Nr. 501184000)



M20 Speaker rod »Ring Lock« with a hand crank, high 920 - 1.520 mm (Art.-Nr. 999921340)



M20 Speaker rod extra high »Ring Lock«, high 1.100 - 1.800 mm (Art.-Nr. 999921368)



M20 Speaker rod, pure white, high 905 - 1.450 mm (Art.-Nr. 999921337)



M20 Speaker rod »short« 250 mm (Art.-Nr. 999921329)

Imprint

© SRV Licht- & Tonanlagen, all rights reserved.

All specifications in this manual are based on information available at the time of publishing for the features and safety guidelines of the described products. Technical specifications, measurements, weights and properties are not guaranteed.

The manufacturer reserves the right to make technical modifications according to legal regulations stipulating the continual improvement of product features. For the safe operation of the unit, this manual and all other required information must be available to all users at the time of assembly and disassembly of the unit, and during operation. Assemble or operate the unit only after reading and understanding this manual, and keeping it at hand at all times at the site.

We are happy to receive your suggestions and proposals for the enhancement of this manual.

Please send us your ideas to the following address:

SRV Licht- & Tonanlagen - Voice-Acoustic Headquarters
Brocksfeld 3
D-27313 Dörverden

Tel.: + 49 (0) 4234 942 777

E-Mail: info@voice-acoustic.de