

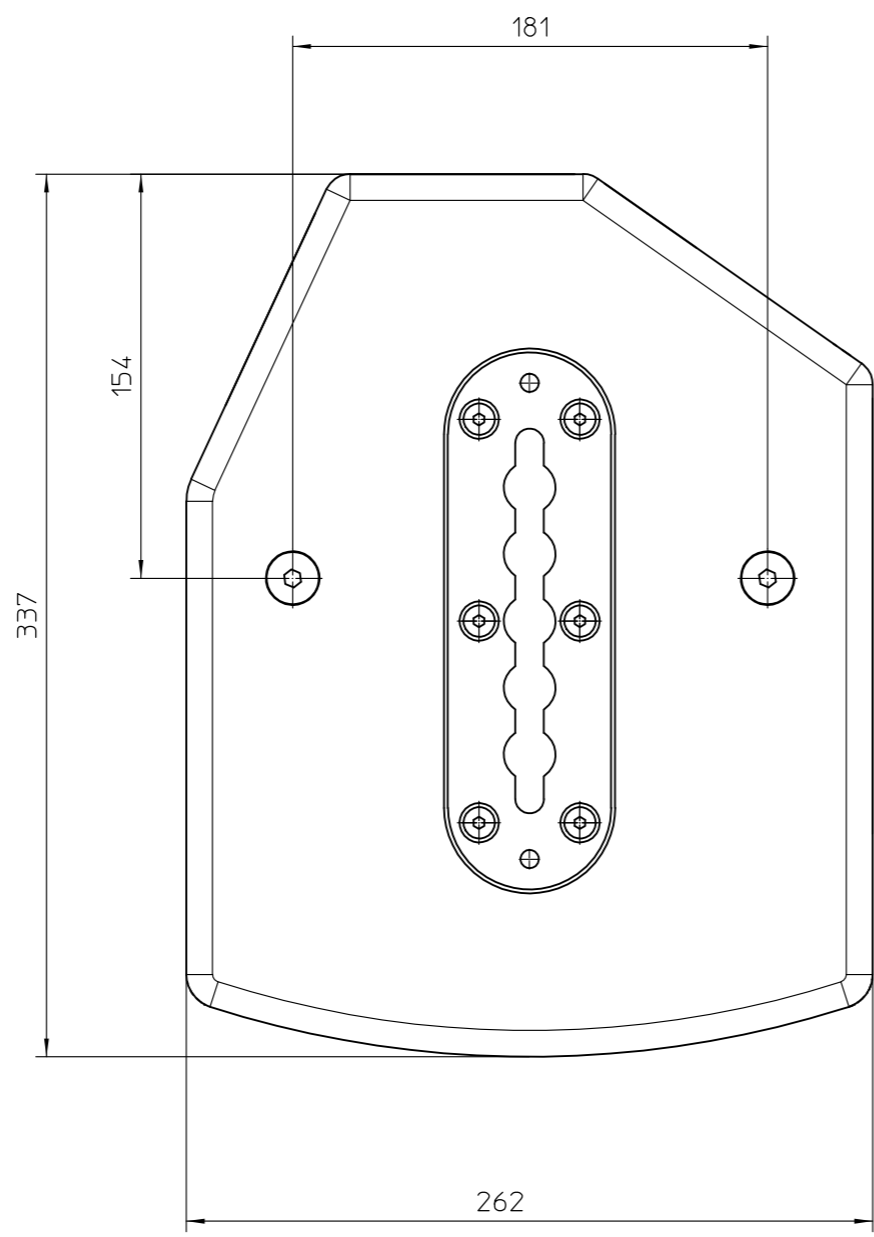

		<a href="http://www.Voice-Acoustic.de">www.Voice-Acoustic.de</a> <a href="mailto:info@Voice-Acoustic.de">info@Voice-Acoustic.de</a>		Maßstab M	Maße: Artikel Nummer:																
<table border="1"> <tr> <td></td> <td>Datum</td> <td colspan="2">Name</td> </tr> <tr> <td></td> <td>Gezeichnet</td> <td>21.09.2021</td> <td>T.Richter</td> </tr> <tr> <td></td> <td>Kontrolliert</td> <td></td> <td></td> </tr> <tr> <td></td> <td>Freigegeben</td> <td></td> <td></td> </tr> </table>					Datum	Name			Gezeichnet	21.09.2021	T.Richter		Kontrolliert				Freigegeben			Bezeichnung Score-8	
	Datum	Name																			
	Gezeichnet	21.09.2021	T.Richter																		
	Kontrolliert																				
	Freigegeben																				
Maße ohne Toleranzangabe DIN ISO 2768-T1 mittel				A3																	
Status	Änderungen	Datum	Name																		



		<a href="http://www.Voice-Acoustic.de">www.Voice-Acoustic.de</a> <a href="mailto:info@Voice-Acoustic.de">info@Voice-Acoustic.de</a>		Maßstab M	Maße: Artikel Nummer:
				Datum Name	Bezeichnung Score-8 Oben
				Gezeichnet - Kontrolliert - Freigegeben -	 A3
				Maße ohne Toleranzangabe DIN ISO 2768-T1 mittel	
Status	Änderungen	Datum	Name		

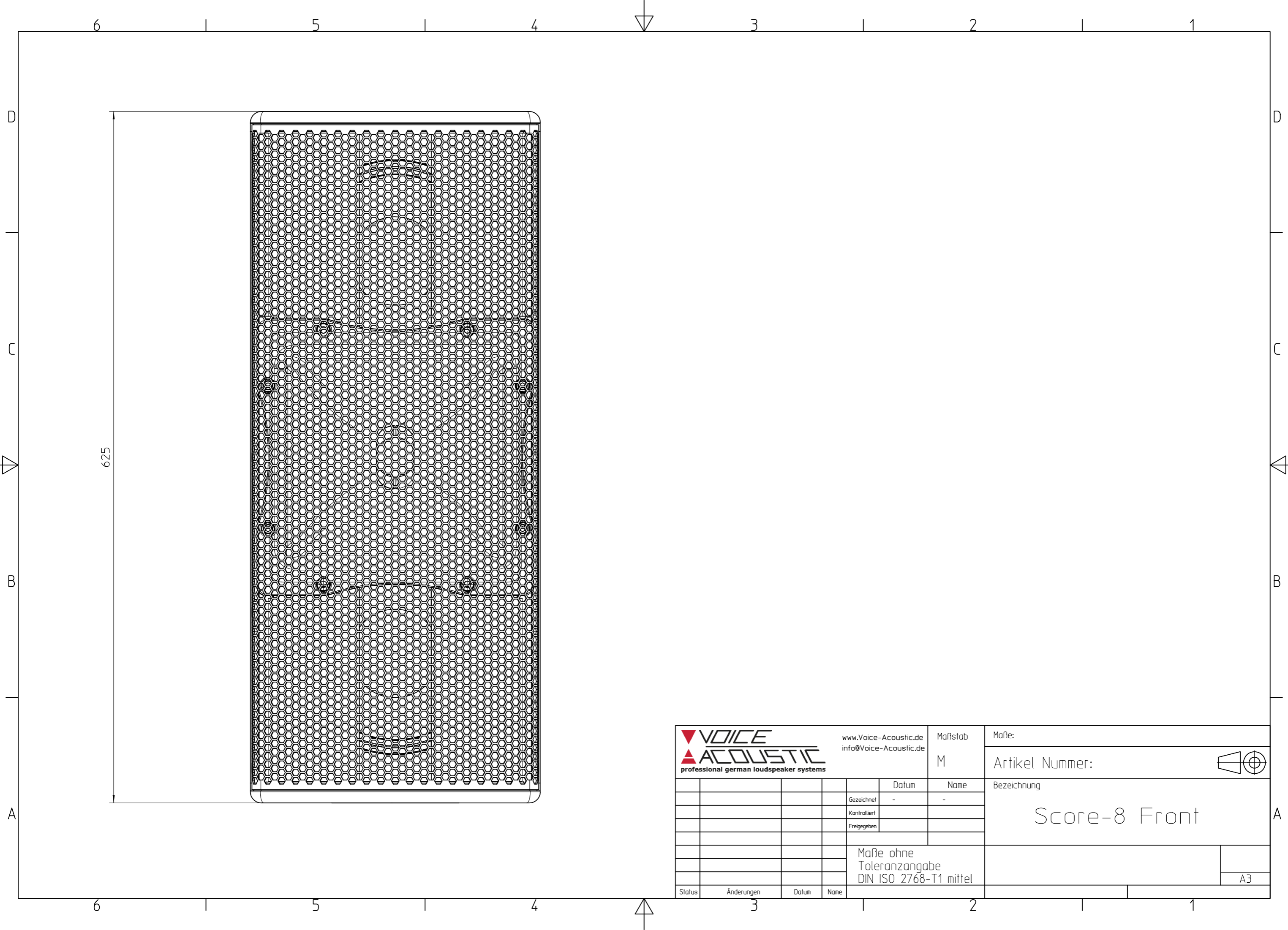

625

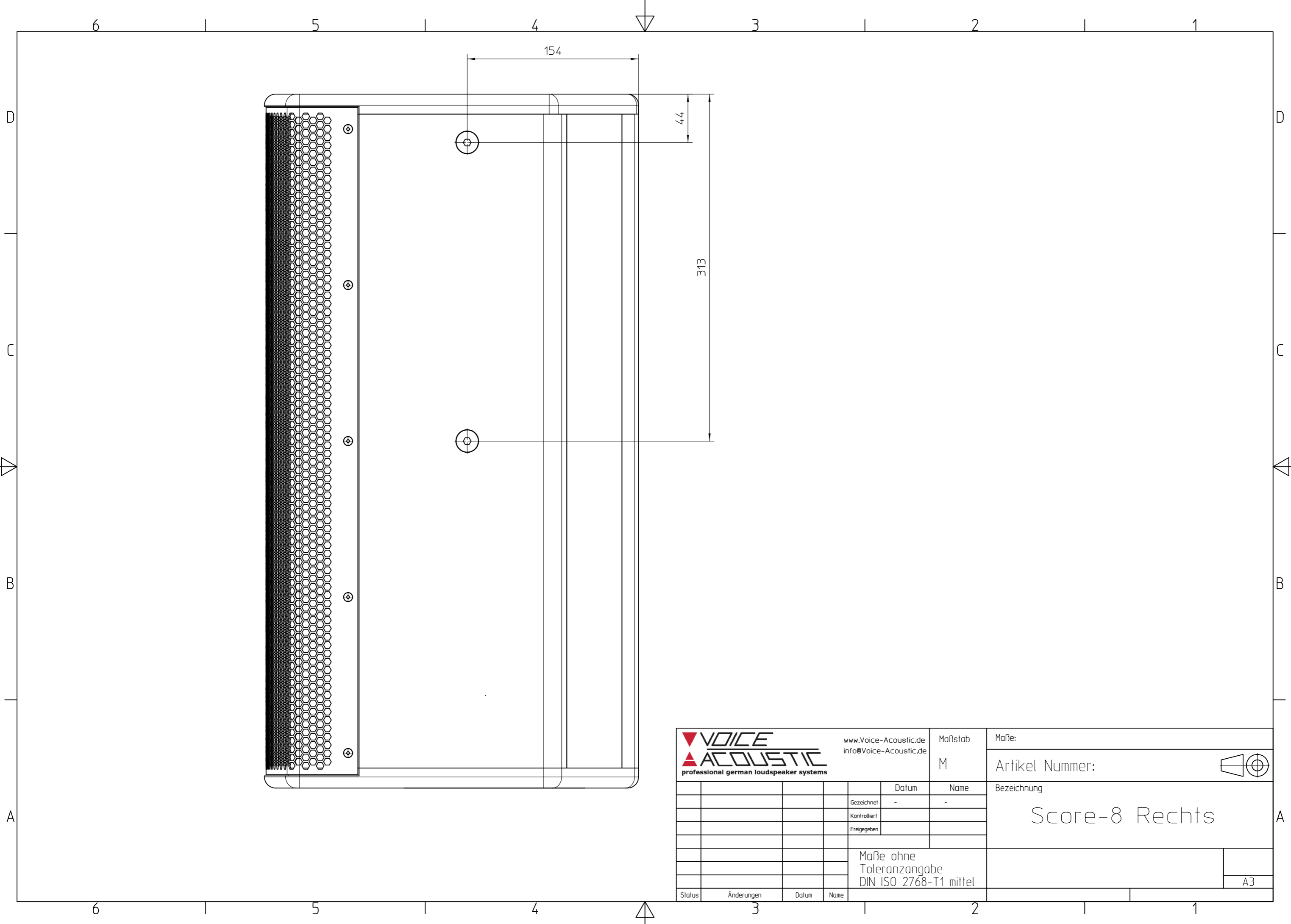

		<a href="http://www.Voice-Acoustic.de">www.Voice-Acoustic.de</a> <a href="mailto:info@Voice-Acoustic.de">info@Voice-Acoustic.de</a>		Maßstab	Maße:
				M	Artikel Nummer: 
			Datum	Name	Bezeichnung
			Gezeichnet	-	
			Kontrolliert		
			Freigegeben		
				Maße ohne Toleranzangabe	
				DIN ISO 2768-T1 mittel	
Status	Änderungen	Datum	Name		
				A3	

Score-8 Front

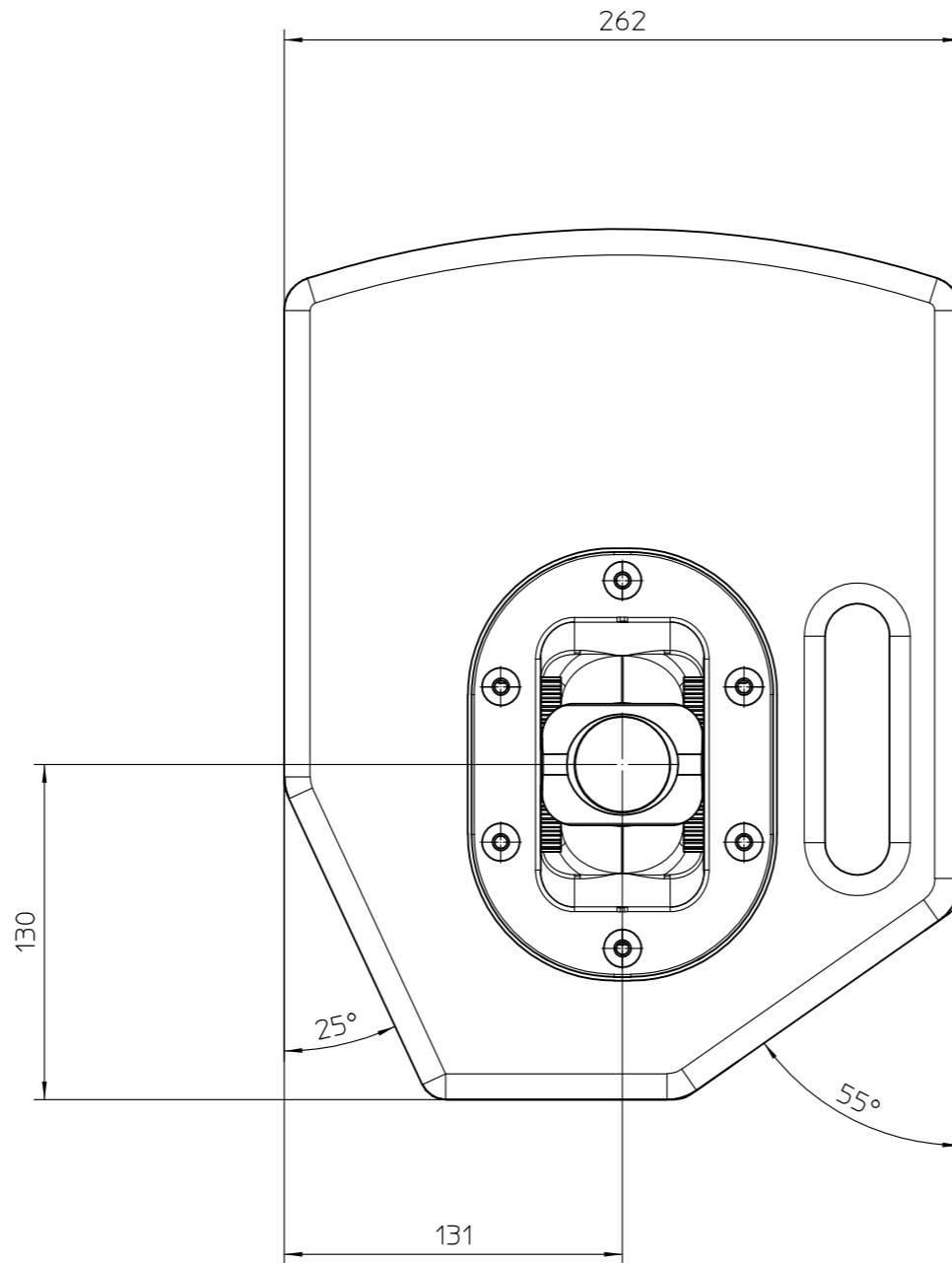

		<a href="http://www.Voice-Acoustic.de">www.Voice-Acoustic.de</a> <a href="mailto:info@Voice-Acoustic.de">info@Voice-Acoustic.de</a>		Maßstab M	Maße: Artikel Nummer:
Datum Name				Bezeichnung Score-8 Rechts	
Gezeichnet - Kontrolliert - Freigegeben				Maße ohne Toleranzangabe DIN ISO 2768-T1 mittel	
Status	Änderungen	Datum	Name	A3	



		<a href="http://www.Voice-Acoustic.de">www.Voice-Acoustic.de</a> <a href="mailto:info@Voice-Acoustic.de">info@Voice-Acoustic.de</a>		Maßstab M	Maße: Artikel Nummer:
					
					Bezeichnung Score-8 Unten
				Maße ohne Toleranzangabe DIN ISO 2768-T1 mittel	
Status	Änderungen	Datum	Name		

A3

D

C

B

A

6

5

4

3

2

1

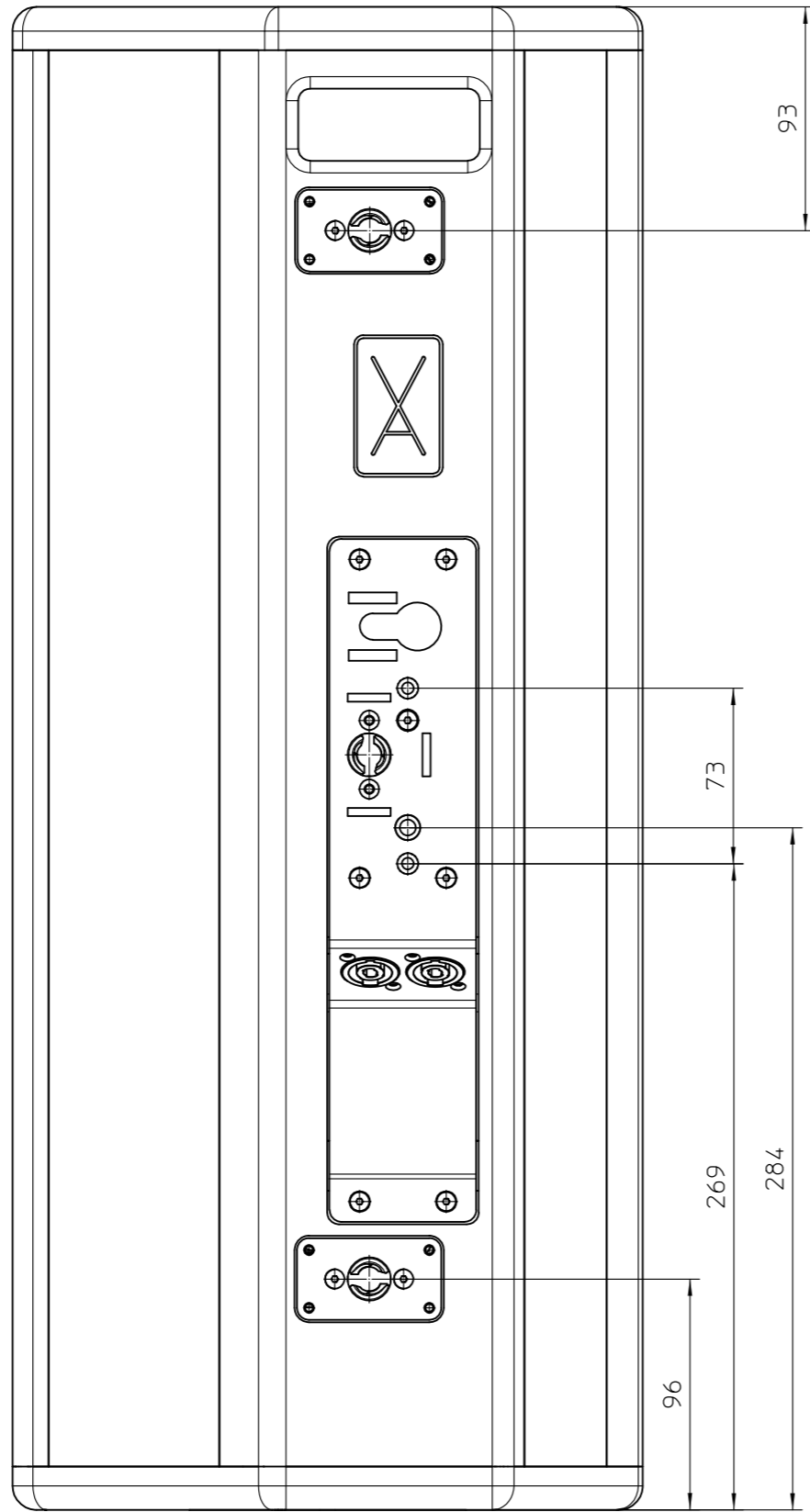

Rückansicht3

6

5

4



3

2

1

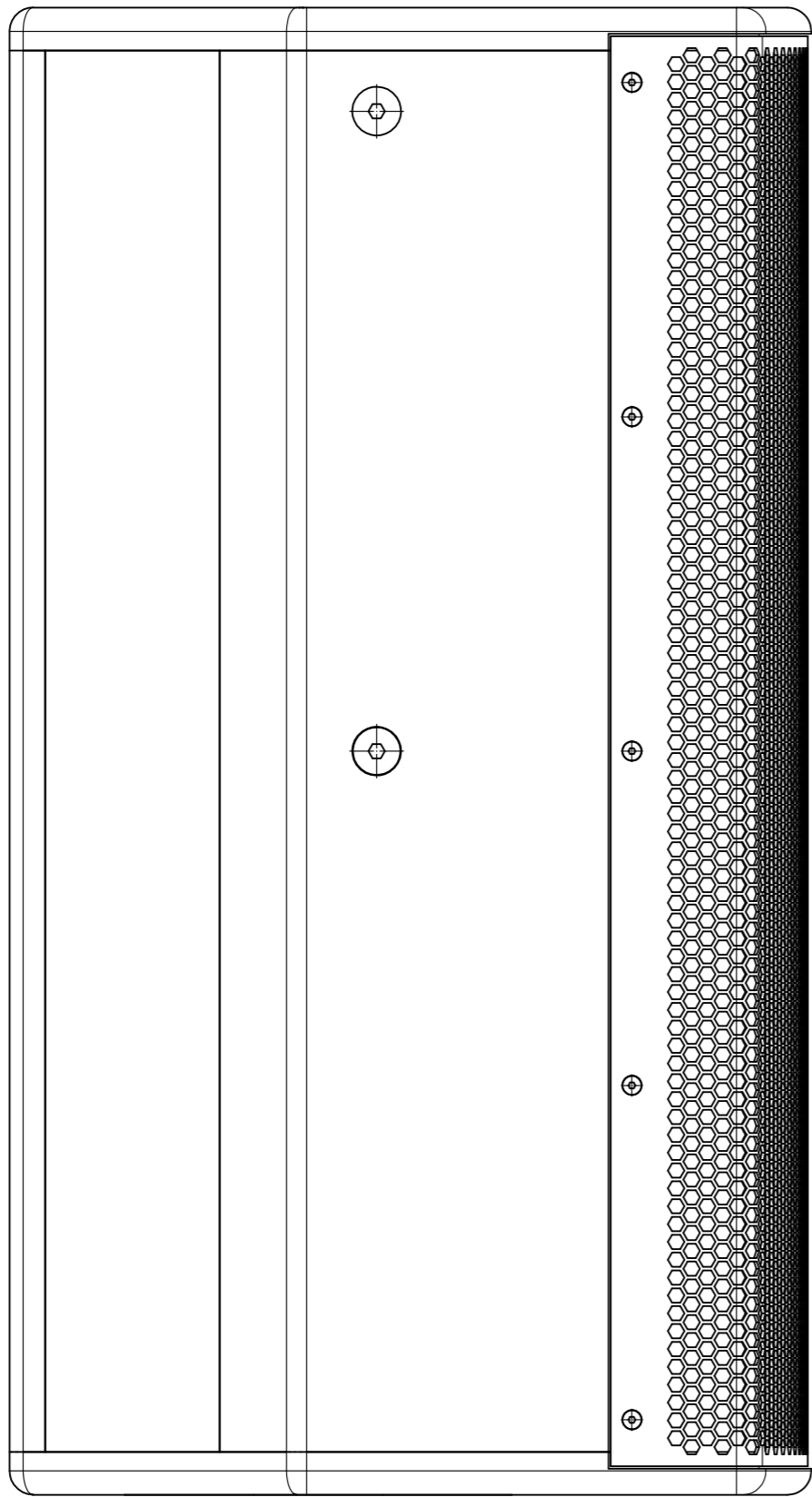
		www.Voice-Acoustic.de info@Voice-Acoustic.de		Maßstab	Maße:	
				M	Artikel Nummer: 	
			Datum	Name	Bezeichnung	
			Gezeichnet	-		Score-8 Hinten
			Kontrolliert			
			Freigegeben			
				Maße ohne Toleranzangabe DIN ISO 2768-T1 mittel		
Status	Änderungen	Datum	Name			
				A3		



		<a href="http://www.Voice-Acoustic.de">www.Voice-Acoustic.de</a> <a href="mailto:info@Voice-Acoustic.de">info@Voice-Acoustic.de</a>		Maßstab M	Maße: Artikel Nummer: 
				Datum Name	Bezeichnung Score-8 Links
				Gezeichnet - Kontrolliert - Freigegeben	A3
				Maße ohne Toleranzangabe DIN ISO 2768-T1 mittel	
Status	Änderungen	Datum	Name		