

1 / Front
 2 / Back
 3 / Top & Base

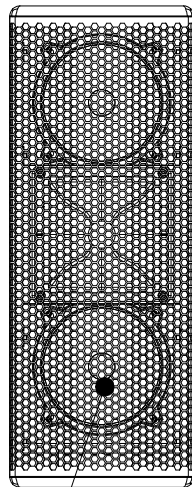

1

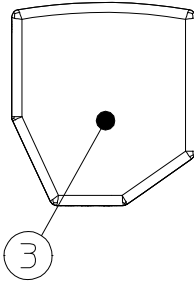
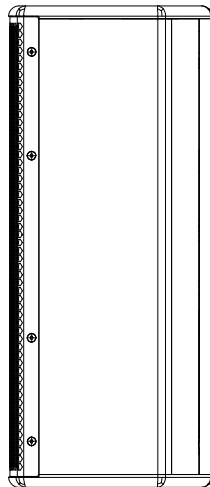
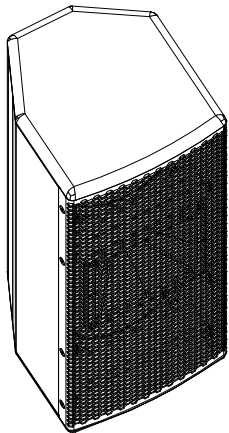
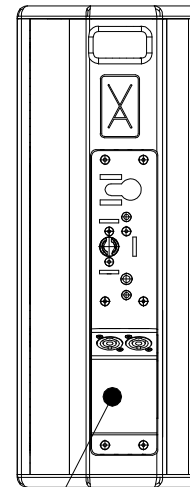
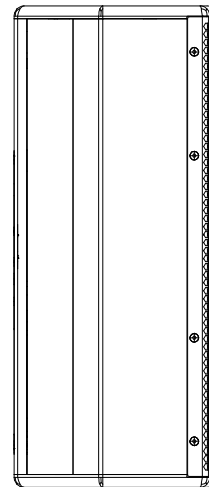

2

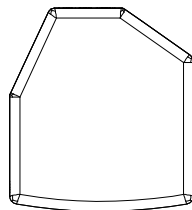
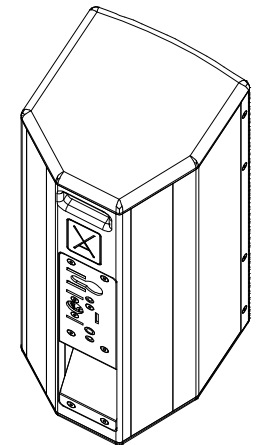

Voice Acoustic www.Voice-Acoustic.de Info@Voice-Acoustic.de		 professional german loudspeaker systems		Zul. Abweichung nach DIN ISO 2768 T1 mittel		Oberfläche Material		Maßstab: 1:5	
				Datum Name		Bezeichnung			
				Erstellt Geprüft Freigabe		Score 5 2 x 5" / 1 x 1" Score 5 Voice Acoustic			
				Alle Rechte nach DIN 34 und BGB vorbehalten!		Zeichnungs-Nr.: Score5_Montagebaugruppe_08.08.2017_Rev.2		Blatt 1 von 1	
INDEX	Beschreibung	Datum	Name	ORIGINAL					

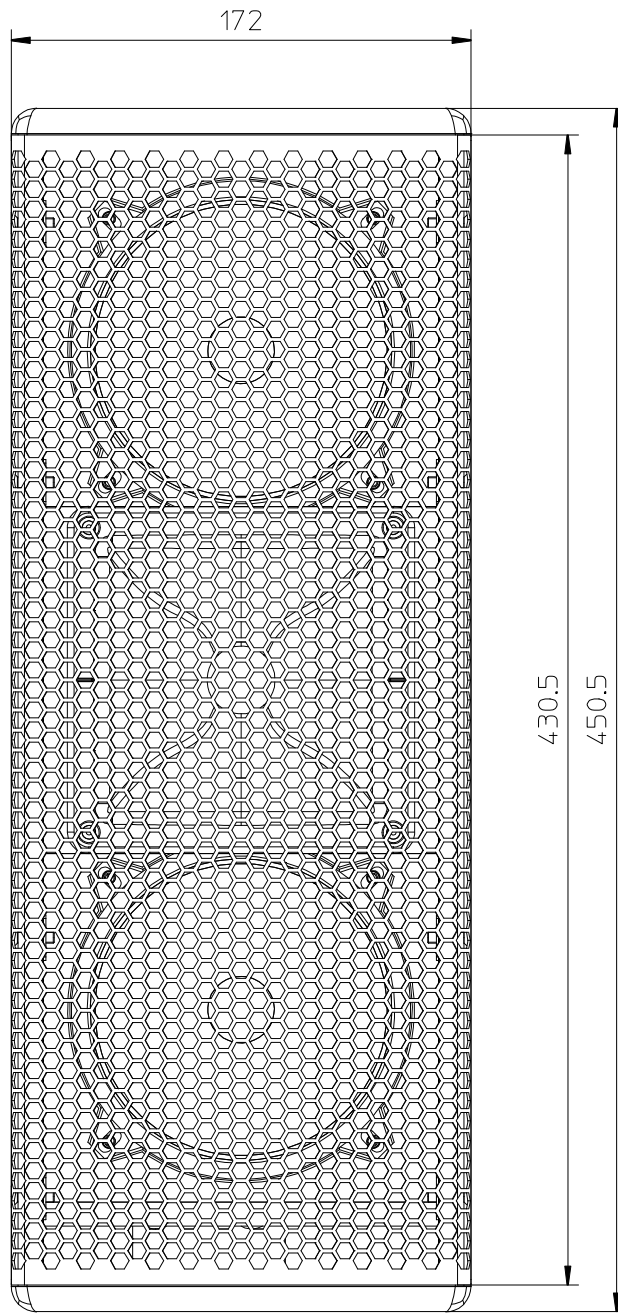

Voice Acoustic www.Voice-Acoustic.de Info@Voice-Acoustic.de		 professional german loudspeaker systems		Zul. Abweichung nach DIN ISO 2768 T1 mittel		Oberfläche Material		Maßstab: 1:2	
				Datum Name		Bezeichnung <h3>Score 5 - Front</h3> <p>2 x 5' / 1 x 1' Score 5 Voice Acoustic</p>			
				Erstellt Geprüft Freigabe					
				Alle Rechte nach DIN 34 und BGB vorbehalten!		Zeichnungs-Nr.: Score5_Montagebaugruppe_08.08.2017_Rev.2		Blatt 1 von 1	
INDEX	Beschreibung	Datum	Name	ORIGINAL					

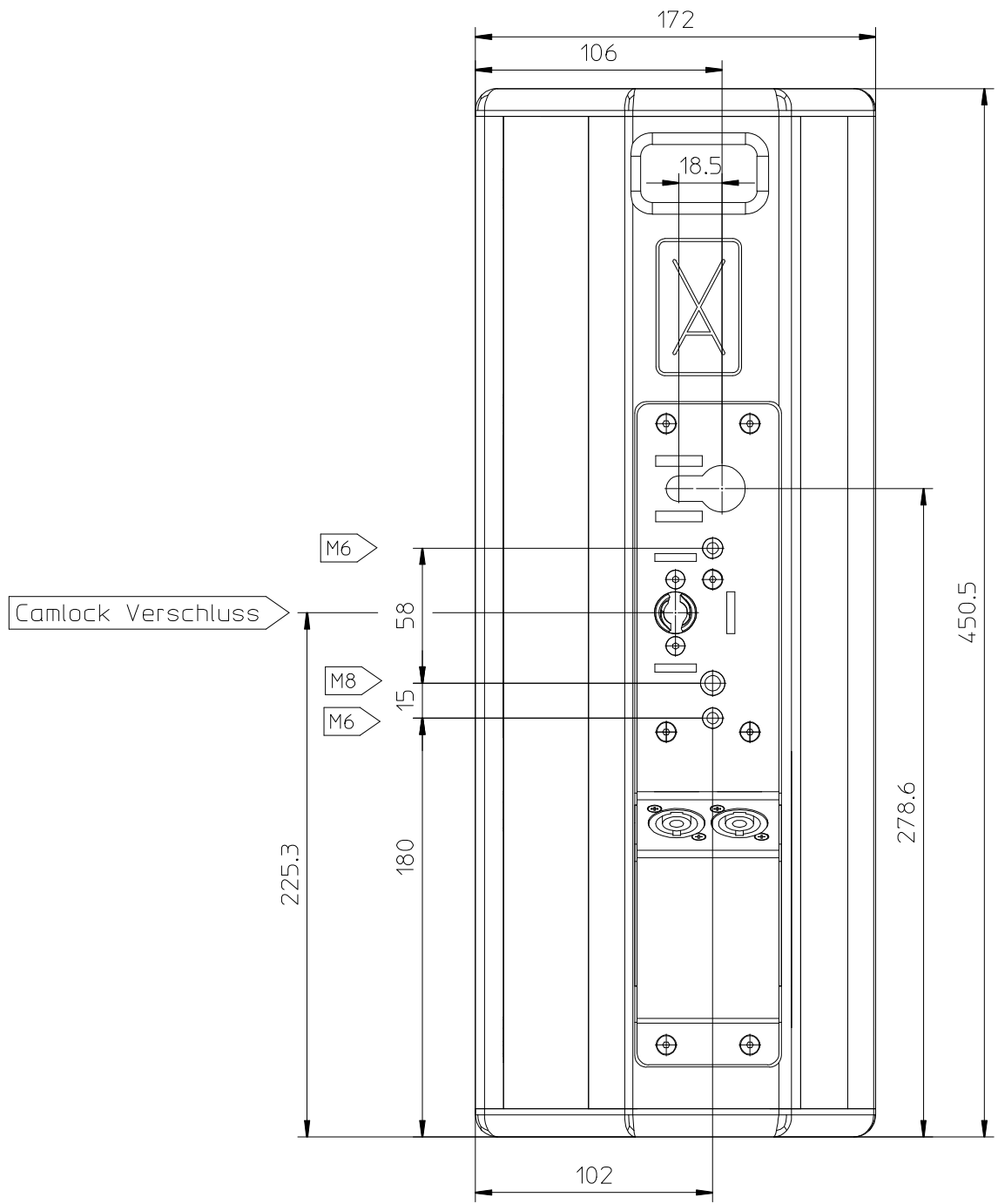

Voice Acoustic www.Voice-Acoustic.de Info@Voice-Acoustic.de		 professional german loudspeaker systems		Zul. Abweichung nach DIN ISO 2768 T1 mittel		Oberfläche Material		Maßstab: 1:2	
				Datum		Name		Bezeichnung	
				Erstellt				Score 5 - Back 2 x 5" / 1 x 1" Score 5 Voice Acoustic	
				Geprüft					
				Freigabe					
						Alle Rechte nach DIN 34 und BGB vorbehalten!		Zeichnungs-Nr.:	
								Score5_Montagebaugruppe_08.08.2017_Rev.2	
INDEX		Beschreibung		Datum		Name		Blatt 1 von 1	
						ORIGINAL			

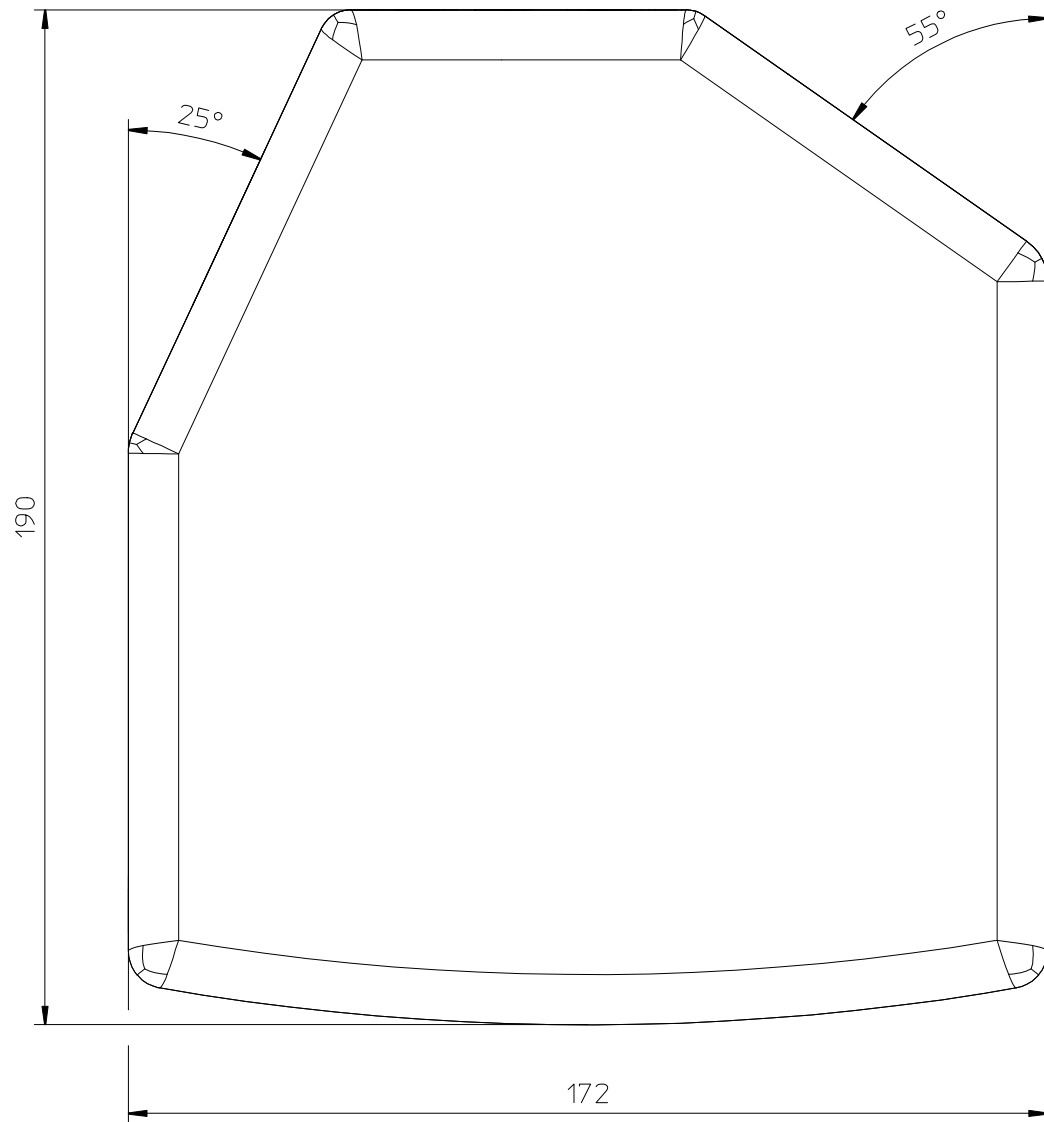

Maßstab 1:2

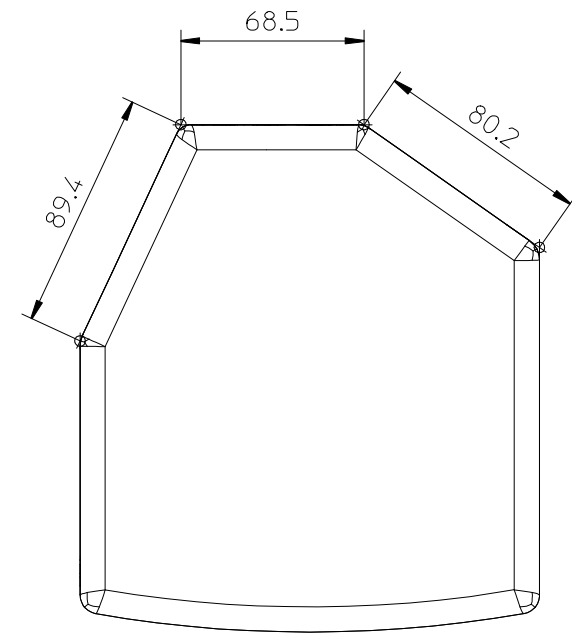

Voice Acoustic www.Voice-Acoustic.de Info@Voice-Acoustic.de		 professional german loudspeaker systems		Zul. Abweichung nach DIN ISO 2768 T1 mittel	Oberfläche	Maßstab: 1:1
					Material	
				Datum	Name	Bezeichnung
				Erstellt		Score 5 - Top & Base 2 x 5" / 1 x 1" Score 5 Voice Acoustic
				Geprüft		
				Freigabe		
				Alle Rechte nach DIN 34 und BGB vorbehalten!		Zeichnungs-Nr.:
						Score5_Montagebaugruppe_08.08.2017_Rev.2
INDEX	Beschreibung	Datum	Name	ORIGINAL		Blatt 1 von 1